



EFFECTIVE. WELDING. IN SERIES.

Guide for use of collaborative
robots in welding operation

COBOT WELDING

Step by step.

BASIS

What does the Cobot do better? Cobot strengths as compared to conventional industrial robots.	4 – 9
Automation and SMEs. The Cobot: As flexible as you need it to be.	10 – 11
Applications and advantages. New possibilities of Cobot welding.	12 – 15
Costs for collaborative welding. The Cobot has its price, though it is much less than you would think.	16 – 17

ADVANTAGES AND USE

More productivity in welding. Simple principle of effect: Preserving quality and increase throughput.	18 – 23
A solution for the shortage of skilled workers? Relieve skilled workers, weld more efficiently, secure the future.	24 – 27
Cobot welding is attractive. Retaining employees, finding employees.	28 – 29
Your step into industry 4.0. Cobot welding as a new key technology for SMEs.	30 – 31
Transparency by networking. The next step is creating transparency.	32 – 33

PRACTICE GUIDE

The matter of safety. Proper handling within the operation.	34 – 39
The key to success. Technology is important. But you and your team are the be-all and end-all.	40 – 41
The targeted path to introduction. Learn how to optimally use your new Cobot tool.	42 – 43
Investing the right amount of time. Sophisticated technology and modern financing concepts.	44 – 49



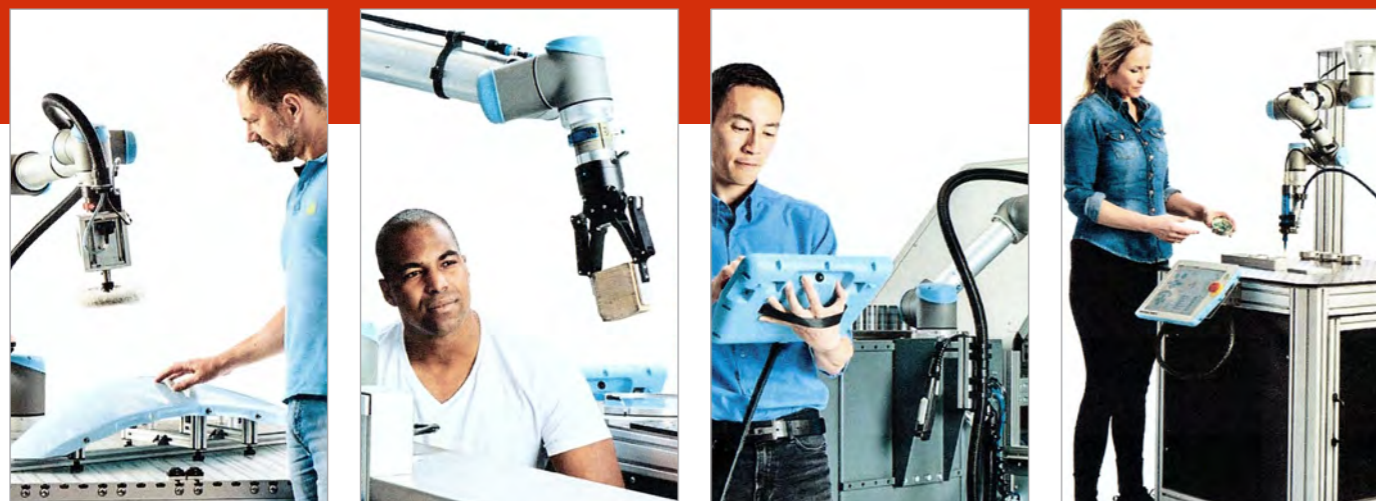

Source: Universal Robots

Collaborative and safe



Quick set-up



Easy to operate



Flexible application

Why is the Cobot better?

Cobot strengths as compared to conventional industrial robots.

The Wikipedia definition puts it all in a nutshell: A collaborative robot is an industrial robot that works together with humans and is not separated from them in the production process by protective devices.

important for welding is that the Cobots do not greatly reduce repeatability of movement sequences, which ensures a reproducible quality comparable to that of their big brothers.

Lightweight instead of heavy to carry

As a result, Cobots focus first and foremost on safety of the employee interacting with it. The most important aspect here is that people avoiding injury to people from kinetic energy acting on them. Since kinetic energy is based on two factors – the speed of movement and the mass of the moving object – it is unsurprising that current Cobots are typically lightweight robots. They weigh only 15-20% of the industrial robots traditionally used in welding. Any restrictions on the load-bearing capacity that this may entail are rarely a criterion for exclusion in the field of welding. What is more

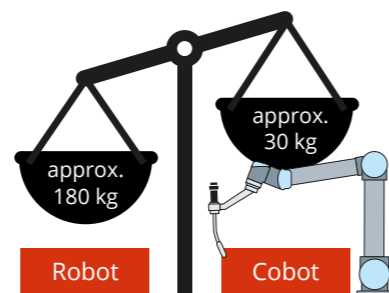

Integrated safety instead of greatest acceleration

Integrated safety technology and powerful sensor systems ensure that Cobots stop their own movement at once even at slight contact with people or obstacles today, thereby preventing injuries or damage. All in all, this is summarised under the theme of inherent safety through power and force limitation. There are also approaches to make conventional industrial robots suitable for collaborative activities, e.g., by adding soft sensor skins. However, these alternatives are not suitable for welding yet due to the specific exposure to UV radiation or flying sparks and welding spatter.

Optimisation of setting time instead of focus cycle time

Conventional industrial robots stand out by being enclosed in a protective environment and can be adjusted to maximise movement speed, always providing an advantage where cycle time optimisation is the most important aspect.

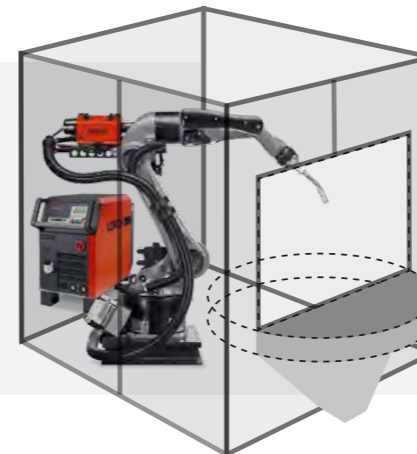

Standard robot installation

- Special plant construction (cell, portal, etc.)
- Special workpiece positioning necessary
- Protective enclosure or protective space monitoring mandatory
- Limited spatial flexibility

Cobot standard installation

- Cobot mounted on a welding table
- Workpieces positioned and fixed on welding table
- Operation possible without a safety fence
- Great spatial flexibility
- Very simple programming, perfect introduction for inexperienced operators



WHY IS THE COBOT BETTER?

This is why conventional industrial robots remain the benchmark for frequently repeating, fully automated large series with relatively low part variance. However, the same robots suffer some deficits in the production of smaller and medium batch sizes and individual order-specific parts. Optimisation of the setting time is more critical as a success or cost factor for efficiently automated production than the cycle time here. This is even more the case for welding since typical travel speeds there are generally rather low and do not change between robots and Cobots.

Innovative operation rather than specialist know-how

Cobots offer decisive advantages in particular for reducing setting times: on the one hand, they offer modern, simple, and intuitive operating concepts, while on the other hand allowing manual positioning of the Cobots in the desired positions. This is a decisive argument in favour of Cobot for many users.

Robot operating concept = specialist tool

- Specific operating concept with dedicated programming language
- Specifically designed for robot operation
- Screen with fixed key operation (partly touch additional functionality) or combination of touch screen and joystick
- Can be operated very quickly by experienced programmers
- Welding software from the robot manufacturer



Cobot operating concept = generalist tool

- Universal surface
- Based on PC systems/smartphones
- Basic operation is intuitive
- Large touch screen
- Practitioner quickly understands how to use it
- Welding software from the welding package manufacturer

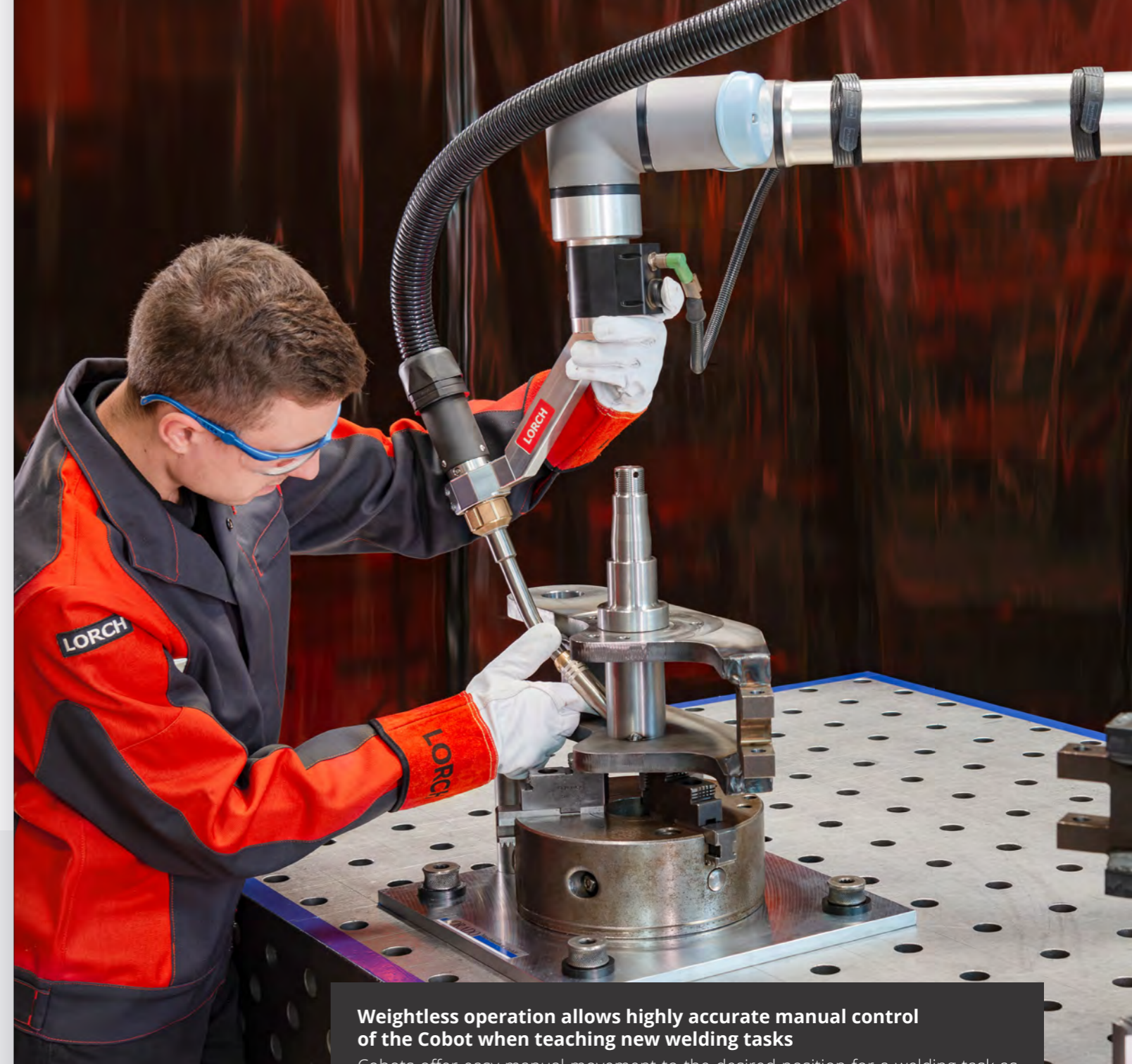

Weightless operation allows highly accurate manual control of the Cobot when teaching new welding tasks

Cobots offer easy manual movement to the desired position for a welding task as a special feature. The Cobot arm is switched to manual mode by holding down a button (ideally a foot button or a button on the robot flange to keep both hands available for robot guidance). The joint motors actively lift the arm weight; it will be suspended in space virtually weightless and can be moved with little effort by pushing and pulling. This is made possible by the Cobot's special sensor technology that otherwise ensures safe operation and immediate interruption of movement on contact. Additional systems may be offered for conventional robots that have a similar function but have to be purchased separately. Cobots usually have this function by default. It is highly recommended for welding processes.

Areas of application Robot versus Cobot.

Types of interaction between humans and robots.

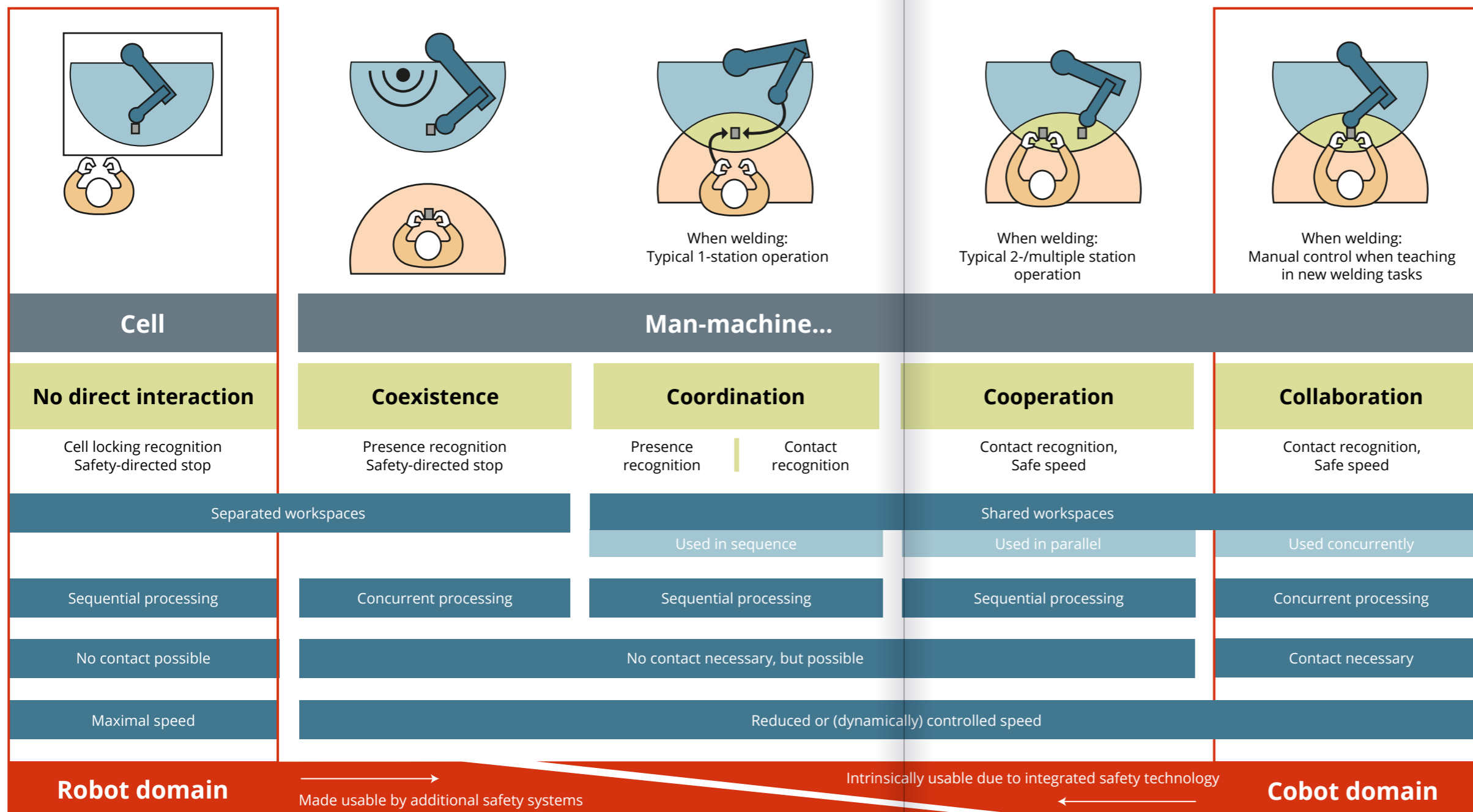

Contact detection requires power and force limitation through inherent control

Implementation at Universal Robots: "Universal Robots' lightweight robots are equipped with internal force controls and up to 15 individually adjustable safety functions. This permits their operation without or with minimal protective devices after a successfully completed risk assessment. The robot continuously monitors the currents in its joints, which are driven by DC servo motors. The robot can determine the forces acting on it from the respective currents and a few other measured and known parameters. It will compare these to the static and dynamic forces expected on the basis of physics in real time. If any unexpected collision occurs, these two values will become misaligned due to the increased mechanical resistance. The robot will stop immediately. A force of just 50 or 100 Newtons can be sufficient to initiate the automatic safety stop in Universal Robots' articulated robots, depending on the setting and model." Universal Robots Whitepaper Collaborative Robotics Safety of Action in Human-Robot Collaboration (HRC) with ISO TS 15066

Safe speed

Impact speed is one of the most significant factors influencing the potential severity of a contact, apart from the robot weight. Therefore, it is necessary to safely limit the Cobot's movement speed. This can be done without any disadvantages for the welding result and productivity for the welding application.

Safety fence or monitored safety area

Operation without safety fence

Literature uses the terms of "synchronisation" or "sequential cooperation" as synonyms for "coordination" as well.

Illustration based on: Fraunhofer IAO, Study Lightweight Robots 2016, p.8 et seq. Cobot Consulting, overview: Different forms of interaction



Source: shutterstock.com/goodluz

Automation and SMEs.

The Cobot: As flexible as you need it to be.

Demands on the metalworking SME, often a typical subcontractor, have changed considerably in the last few years. While it used to be perfectly possible to deliver larger quantities to customers in the past, the current trend grows towards warranted just-in-time deliveries, or at least shorter delivery intervals, without relieving pressure from unit costs. This requires the development of higher in-house storage capacities by the supplier to preserve delivery and quality performance. This is associated with the disadvantage of more tied-up capital and higher logistics costs. However, customers increasingly reserve the right to make design adjustments to parts at short notice, causing an additional risk when stocking call-off parts. This can be solved by flexibly designed automated production, in particular for smaller series or batch sizes. It may sound simple enough, but it used to be virtually impossible in the area of welding before. Though there have always been

efforts to offer solutions for small and medium-sized enterprises in the area of industrial robots, alignment with mass production customers' needs (in particular in the automotive industry) has been too dominant to permit any serious improvements for small batch manufacturers. The jump to automated welding with an industrial robot remained enormous, both in terms of required investments and know-how. Other mechanisation solutions for circular, longitudinal, and corner seam welding were and continue to be only found in partial or special solutions.

Welding with the Cobot: optimal for small series.

This gap is what welding with the Cobot now fills. It offers the first solution to precisely meet the requirements for small and medium-sized series typically found in SMEs, no matter if they have 5 or 500 employees.

Another decisive advantage is that the company itself remains in control of the automation and does not become dependent on external experts. The Cobot training programme takes only 2-3 days from commissioning to operator training and will be performed right on site at the company. An important aspect of a welding solution is that functions that significantly sim-

plify and accelerate the process and parameter determination for the welds are included in the software. This is something that needs to be specifically considered when deciding which Cobot solution to use.

Advantages of Cobot welding

- Simple operation and minimal setting and programming effort
- Sufficient repeatability for welding
- All necessary degrees of freedom and functions available during welding
- Low space requirement due to simple mounting on a welding table (without additional protective enclosure)
- Cobot is closer to a tool than a machine
- Its operational introduction is much easier

A device for the middling range – in the best sense. Optimal for medium-sized enterprises.

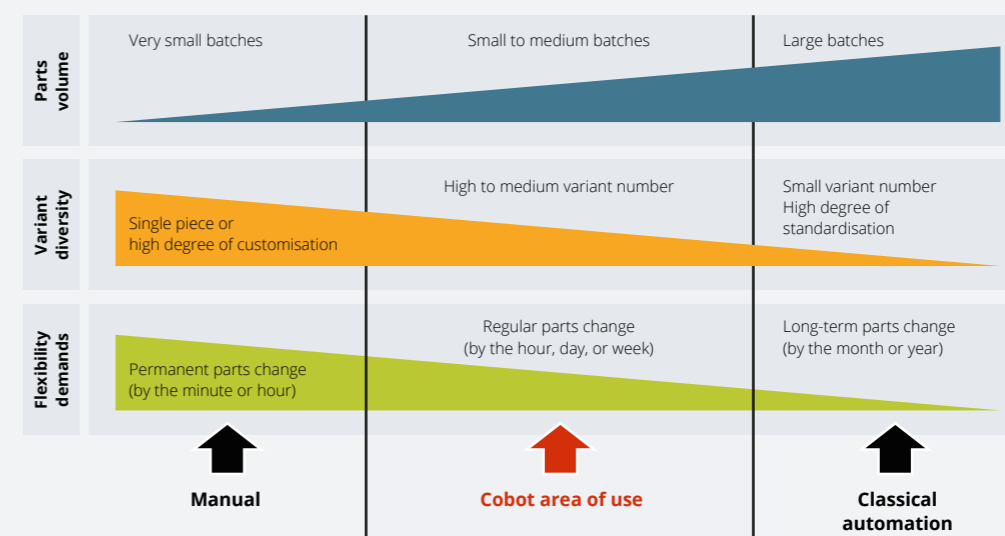

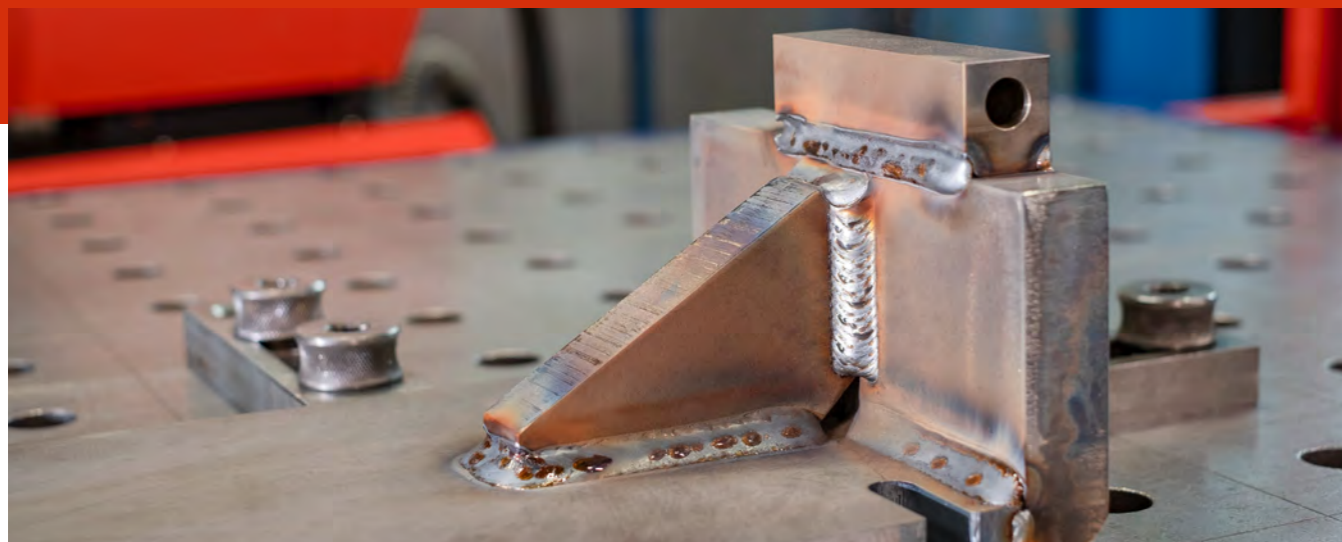

Applications and advantages.

New possibilities of Cobot welding.

The following general statements apply: A "Cobot" designed for welding, such as the UR 10e, is able to perform all but a very few welding tasks that arise in an operation.

Linear and circular movements alike are easily possible with the Cobot, as is smoothing of the inner and outer radii. These processes can be combined into any contour movements.

Cobots are still a relatively new kind of industrial robot. Limitations in the functional scope for special disciplines, which welding still belongs to, are rather the rule as a result.

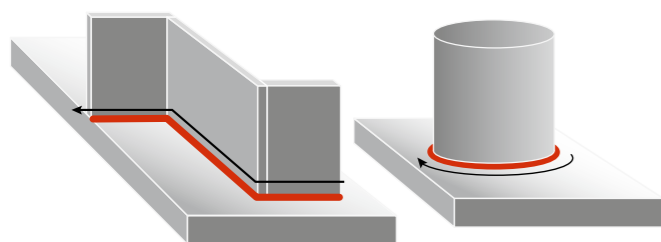

Cobots are suitable for material thicknesses from 1 to 15 mm that can be welded mostly in a single layer.

Multi-layer welds and weaving is generally possible. However, that takes a bit more experience in handling the Cobot and automated welding in the operation. Apart from this, the provider's assistance functions often provide some support in such cases.

There is virtually no limitation from a material-technical point of view.

Steel and stainless steel generally can be welded easily. For softer aluminium wires, a push-pull torch system should be used to accommodate the much longer torch hose package.

"Tolerance handling" is much more important for automated welding.

In contrast to manual welding, where the welder with all their human sensory organs is able to react to irregularities and deviations, robot or Cobot welding requires a much more tolerance-adjusted starting situation where workpieces are concerned. This is reflected in higher demands to accuracy of weld seam preparation or device construction. The following rule of thumb can be used as a reference:

Experience has shown that workpiece fixtures originally made for manual welding are not always suitable for use with robots.

The larger Cobot models are generally recommended to stay as flexible as possible in terms of part sizes.

The UR 10e, for example, has a maximum reach of 1,300 mm. In this context, it must be noted that it becomes more difficult to implement a perfectly precise track movement across a longer path the closer a Cobot system comes to its maximal extension. However, this is a key requirement for welding. Therefore, operations that focus on parts with very long, straight weld seams in automation should also consider other automation options, such as tractor systems.

**Maximal tolerance
= ½ of the wire diameter**
The tolerance for a 1 mm wire should not exceed 0.5 mm.

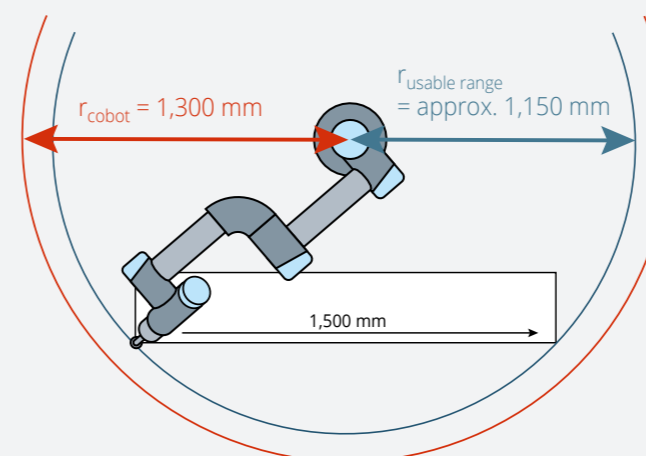

Max. weld seam length approx. 1,500 mm

The sizes named are reference values that may be optimised by additional welding table setup but will then require adjustments to the Cobot safety settings.

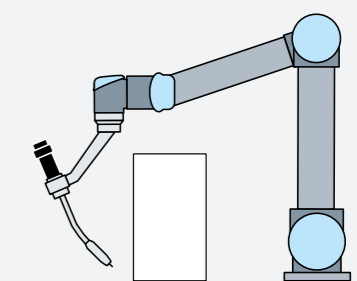

Max. part height approx. 500 mm

Industrial robots may be of advantage for special welding functions.

The controls of conventional industrial robots still have an advantage at the moment if the workpieces to be welded require demanding welding functions, however, such as seam tracking by pendulum welding with an arc sensor, or an AVC function for torch distance adjustment, as is typically used for particularly thick and thin materials, and for large workpieces.

Read more:



Vertical welding with SpeedUp

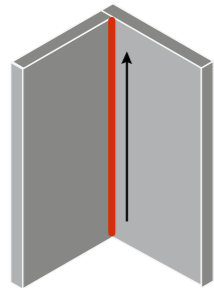

However, the Cobot welding functions are expected to continue to develop step by step in future.

Integration of additional external manipulators is not a Cobot standard discipline. As an alternative, special processes provide a remedy.

Positioners mostly put larger workpieces to be welded from all sides into the closest to optimal tray position for the respective weld seam to be processed next. Equally, turntables or tilt-turn tables as well as traversing axes are found more frequently in robot automation. However, these generally mean that collaborative use is no longer possible easily and additional safety precautions are required.

If you want to weld without a positioner, special MIG-MAG welding processes, such as the Lorch SpeedUp for vertical welding or 360° welding, can also be used to weld workpieces that are fixed in position on the welding table well and efficiently without additional repositioning.

MIG-MAG welding generally is the ideal process for robot welding. This also applies to the Cobot.

Welding of TIG applications with automated wire supply is possible. However, it should be assumed that implementation will have more of a project character. Reduced part accessibility due to the cold wire feed at the torch is one aspect to be considered in the feasibility analysis. In any case, an introduction partner with the expertise in automated TIG welding to match should be involved.

CHECKLIST

Cobot or robot

Which one is a better fit for my operation?

Parts	
Material thicknesses mostly between <input type="checkbox"/> 1 and 15 mm (aluminium from 2 mm onwards) <input type="checkbox"/> Weld seam length < 1,500 mm	Material thicknesses mostly between <input type="checkbox"/> 0.5 and 3 mm or <input type="checkbox"/> > 15 mm <input type="checkbox"/> Weld seam length > 1,500 mm
Production characteristics	
<input type="checkbox"/> Smaller and medium-sized batches <input type="checkbox"/> High part variance <input type="checkbox"/> Frequent workpiece change	<input type="checkbox"/> Large and very large batches <input type="checkbox"/> Low part variance <input type="checkbox"/> Occasional or no workpiece changes
Available space	
<input type="checkbox"/> Limited	<input type="checkbox"/> Available
Robot operating and programming experience	
<input type="checkbox"/> None	<input type="checkbox"/> Already available in the house
Cost focus on	
<input type="checkbox"/> Low equipment costs (minimal setting times)	<input type="checkbox"/> Low production unit costs (minimal cycle times)
Investment willingness	
<input type="checkbox"/> < EUR 100,000	<input type="checkbox"/> > EUR 100,000
Yes to a Cobot solution	Yes to a robot solution



Source: iStock.com/Santje09

Costs for collaborative welding.

The Cobot has its price, though it is much less than you would think.

Although collaborative robots represent the fastest growing market segment in industrial robots in percentage terms, their share of the overall market is still likely to be low. Cobots may be even more expensive than their much heavier brothers and sisters since economies of scale of the Cobot manufacturers are still low and lightweight construction technology tends to raise up costs.

Cobot acquisition costs are assumed to be lower due to four factors:

1. Lower peripheral costs. The basic collaborative nature of the Cobots means that expensive protective enclosures or additional safety technology can be largely dispensed with. However, glare and sight protection as well as fume extractors are required, just as for manual welding workplaces.

2. Low programming and set-up costs, mostly due to the very simple and intuitive operation of the Cobots.

3. Lower training costs. While conventional robots require several weeks of training plus the associated travel and accommodation costs until an employee is "fit" for the robot, this effort is greatly reduced in Cobots. Based on the experience gained from a large number of installed Cobot welding systems, a two-day training course (which can be performed at the customer's site) is absolutely sufficient to be able to work directly with the Cobot. This minimises lack of availability of staff to the greatest degree.

4. A different approach: The Cobot is introduced rather like a tool, while robot installations are more reminiscent of a machine. The scope of services realised at the start is higher

with conventional robots and thus automatically also the costs.

Mid five-figure range

Experience shows that the initial acquisition and implementation costs for a welding Cobot are only about half of the total costs for a conventional welding robot system. While high-quality Cobot packages specifically designed for welding are currently priced at EUR 60,000 to 70,000, the total cost of industrial robot installations remains clearly in the six-figure range. Robot systems with great flexibility (covering a larger part variance) can bring the overall system to several times the costs of the pure cell with welding technology equipment. It should be mentioned that the functional scope or application scope of a conventional robot solution actually is also more extensive than that of a welding Cobot at introduction, too. However, it depends on external support with the corresponding robot know-how to a much greater degree. The Cobot has the decisive advantage that competence in robot operation

and set-up for new welding tasks is developed in the company from the very beginning, considerably reducing follow-up costs. Extensions to the entry-level system are also possible later, so that the Cobot can gain the functions it needs bit by bit. The Cobot welding system also can very quickly be used in production to increase productivity and capacity. Average amortisation times of about one year are generally indicated for collaborative systems.

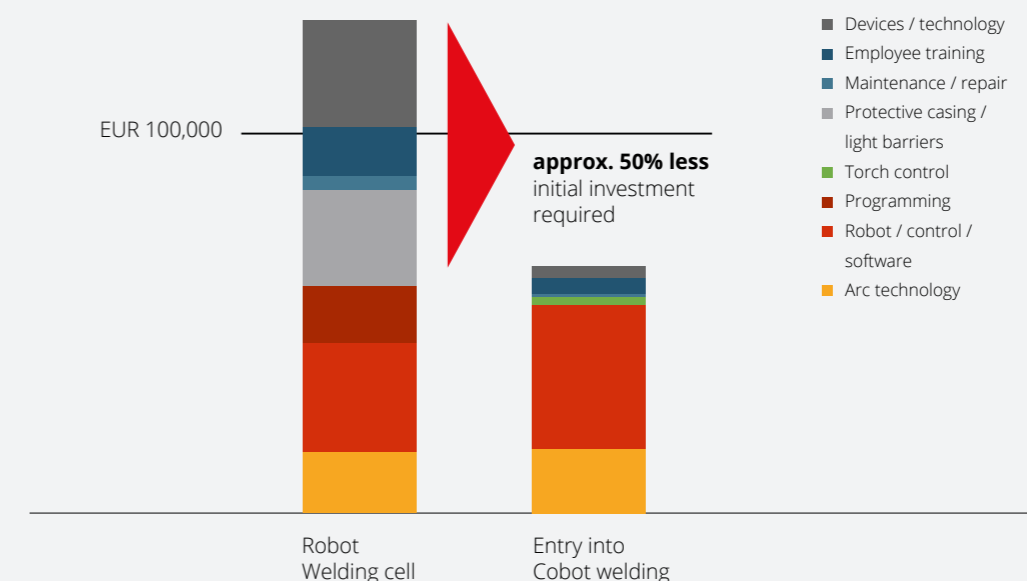

ADVANTAGES AND USE

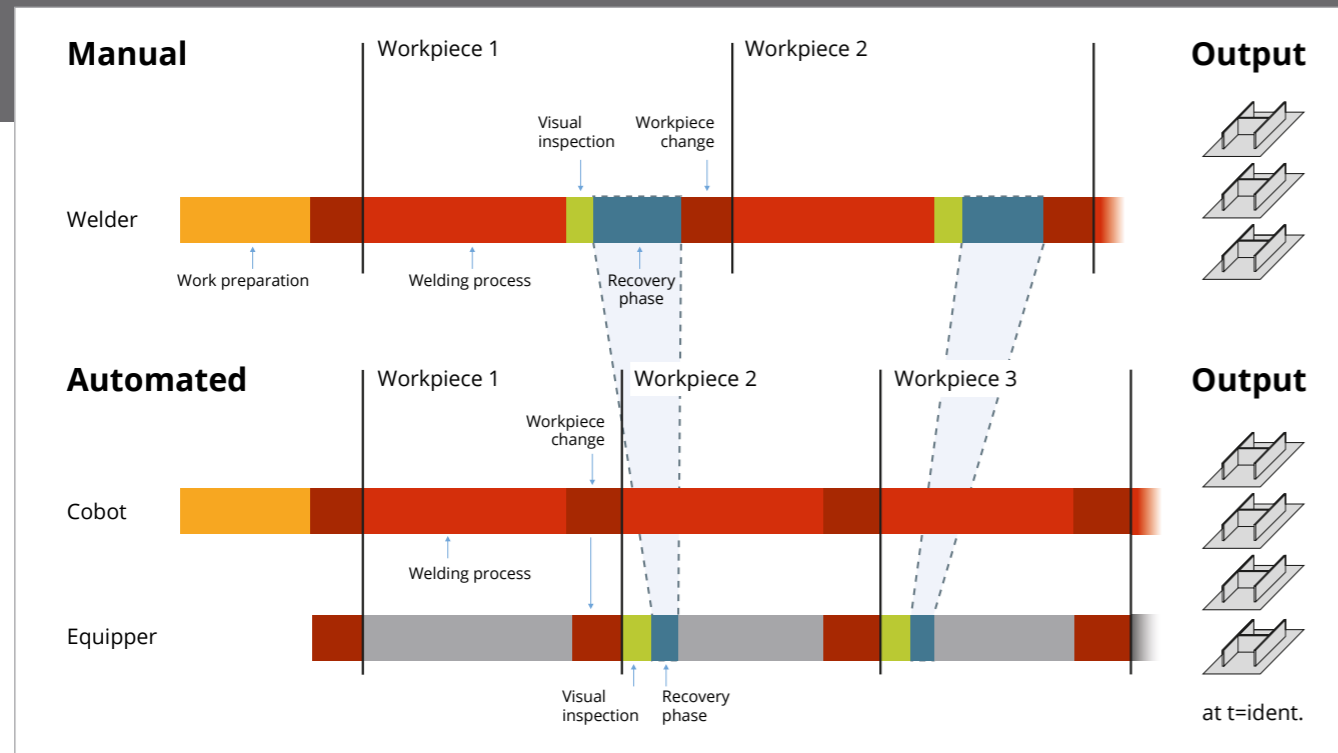

Sequential process arrangement in manual welding versus division of labour in the Cobot

More productivity in welding.

Simple principle of effect: Preserving quality and increase throughput.

Whether a robot welds faster than a welder has been subject to discussion for as long as robots have been used for welding. Generally, they are not. The welding process is rather slow in and of itself. It is performed at the same speed by man and machine alike. This means that Cobot welding is not primarily about acceleration the

welding process, but about increasing productivity across the working day, week, or month or in relation to a job. Productivity is defined as the ratio between output and input.

$$\text{Productivity} = \frac{\text{Output quantity}}{\text{Application quantity/time}} = \frac{\text{Output}}{\text{Input}}$$

What is the productivity gain in Cobot welding?

The answer is not in the welding phases as such but in the secondary times in between.

Welding is a very strenuous activity that requires great focus in order to coordinate the various aspects such as precise torch guidance, arc behaviour, material melting, workpiece tolerances, and joining them to form a reliable weld seam. The entire human sensory system is required in the process. The process also takes place under difficult conditions, as the arc releases a considerable amount of energy and heat, which also affect the welder.

The welder needs a period of recovery after a certain welding time in order to maintain performance and deliver repeatable quality.

A Cobot or a classic robot does not need such a recovery time. The part throughput thus is increased as long as workpieces are fed to these quickly enough to be processed. Further

throughput gains are possible by decoupling the visual quality control and additionally optimising the workpiece insertion and removal process in a targeted manner.

It can also be assumed that a further advance in productivity as compared to manual welding is achieved simply because the Cobot delivers a constant output no matter the time of day. The welder is subject to the human performance curve, which varies across the day. It is mostly reflected in the different lengths of recovery periods required. However, it may also negatively impact welding quality, which increases rework effort. Monotonous routine activities in particular can be a downright quality killer.

Cobot welding, on the other hand, warrants consistent quality and constant output.

Output can also be increased considerably by optimising plaser utilisation (operation of two Cobots by one loader).

PRODUCTIVITY: AVERAGE PERFORMANCE CURVE PER DAY

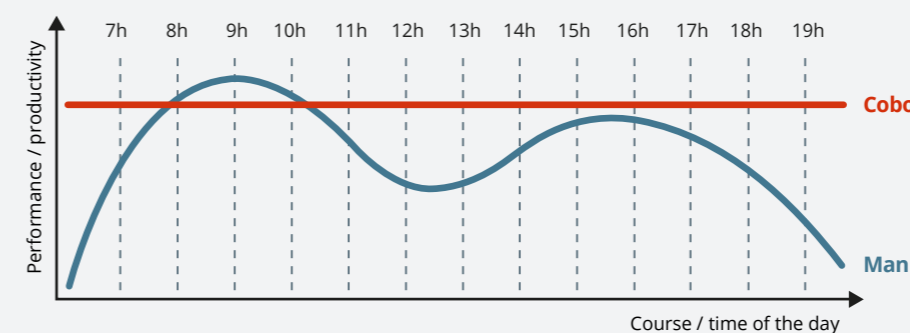

Cobot: The more routine and similar the welding tasks, the more suitable its use.

Man: The more varied and individual the production, the more suitable is manual labour.

The Cobot welds more quickly after all!

This chapter started out by stating that a welder is generally just as fast as the robot during the actual welding process. However, this statement is not entirely accurate, as it ignores certain aspects and options offered by use of robots. The welder tends to apply a bit more throat thickness than necessary when welding manually, therefore applying too much material. Cobot welding can coordinate the Cobot travel speed and deposition rate of the welding system to achieve the most precise throat thickness possible. The optimised material feed immediately translates into a faster welding. The option of using a more suitable welding procedure for the respective welding task than the one used before should not be underestimated either. State-of-the-art high-end welding power sources with their sophisticated measurement and control technology offer the possibility of specifically modifying the arc for the best possible results in terms of welding quality and welding speed. Although these special procedures are also used in manual practice, they are generally only used where the specific advantages are correspondingly

large and sufficiently frequent at a workplace. If this is not the case, these processes are rejected by the welder for various reasons: e.g., due to specific noise development (twin pulse), increased welding speed (which leads to higher concentration or coordinative stress for the welder) or unfamiliar handling (higher demands on the accuracy of the torch guidance). A Cobot as a repeatable automation tool knows no preferences in this respect and allows additional productivity and quality gains.

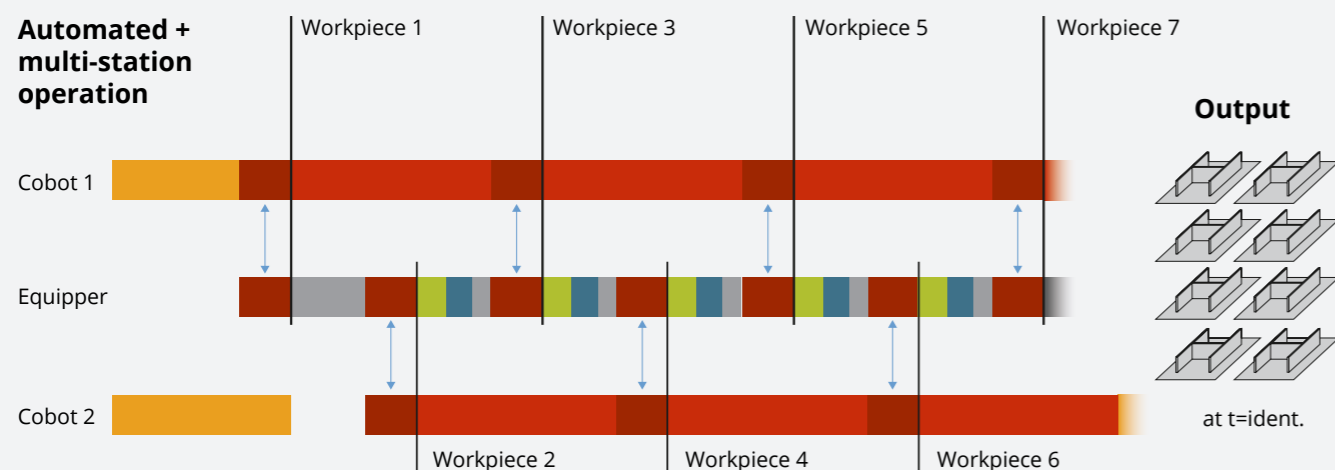

Maximum productivity by cycle optimisation for the pick-and-place operator in Cobot multi-station operation.

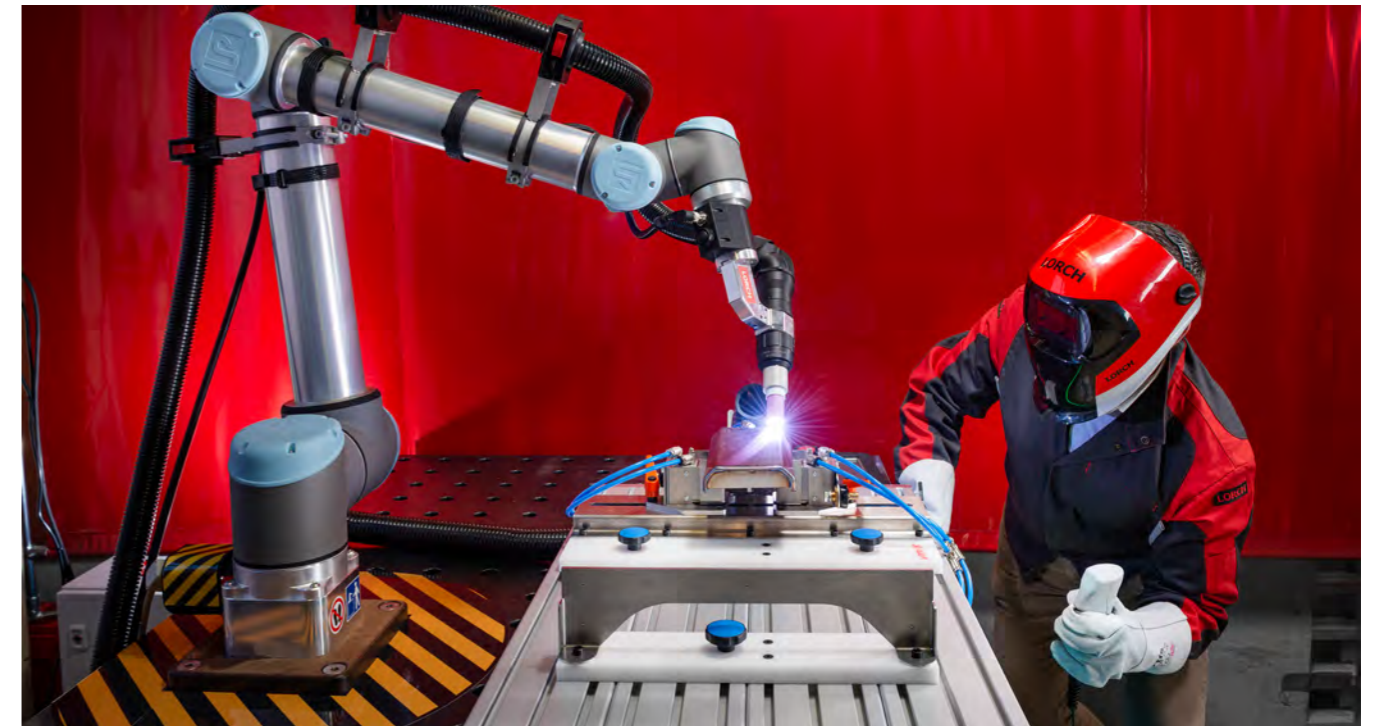

What needs to be considered?

In order to actually realise all the aforementioned productivity gains, the set-up and work preparation effort must not cancel them out. This may be rather unproblematic in principle in large-scale production. However, with the production of small and medium-sized series and frequently changing parts predominantly found in medium-sized companies, this is one of the central challenges in automated welding.

the time saved without investing in any new premises. This secures the company's growth and future viability.

This is exactly where the Cobots currently play their advantage: They are designed for quick set-up and simple, intuitive operation. Once saved, welding tasks can be quickly recalled by simple list selection. If this is combined (ideally from the beginning) with an appropriate approach to work preparation (using jigs and markers or templates for repositioning fences and jigs), then the use of Cobots opens up considerable potential for increasing productivity in welding operations.

The effect on a company's capacity adds another aspect to productivity. If, for example, an operation manages to increase productivity so that the same number of parts can be produced in half the time, it will optimally be able to double its capacity at the same time. Additional parts can be produced in

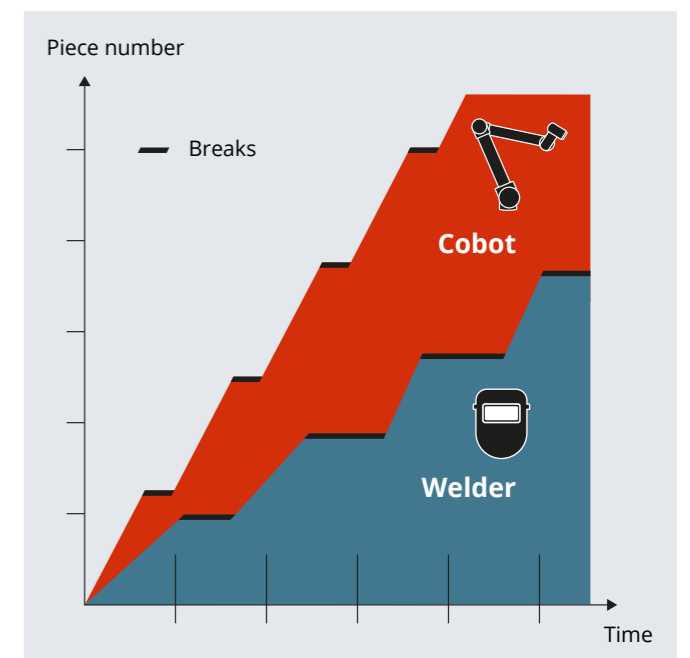

Increased productivity through reduced interruption times and more constant processing times (schematic representation).

**Productivity view:
Cobot use in smaller operations.**
Example calculation

Scenario 1:
1-welder operation

Monthly analysis	Manual	with 1 Cobot	with 1 Cobot	with 2 Cobots
Welders	1	1	1	1
Cobots	0	1	1	2
Loaders	0	0	1	1
Welder support per Cobot	0 %	100 %	25 %	25 %

Output view (units)				
Welder output / month	1.000	0	750	500
Cobot output / month		1.350	1.350	2.700
Total output	1.000	1.350	2.100	3.200

Input view (euros)				
Welders wage costs	2.800	2.800	2.800	2.800
Welding system leasing fees	300		300	300
Cobot system 1 leasing fees		1.200	1.200	1.200
Cobot system 2 leasing fees				1.200
Loaders wage costs (production helper)			1.600	1.600
Total input	3.200	4.000	5.900	7.100

Productivity factor (output to input)	0,32	0,34	0,36	0,45
Increase as compared to manual work (approx.)		5 %	10 %	40 %

+ Operation-specific quality increase

The productivity increases listed do not consider any further savings in rework and scrap compared to manually performed welds. The quality improvements possible from use of Cobots vary from company to company, but can lead to a considerable increase in productivity, in some cases many times over.

Scenario 2:
Transfer to multiple-welder operation

	A	B	C	D	E
	Current situation	Forecast	Forecast with Cobot	Increased Cobot use	Increased Cobot use
Welders	5	3	3	3	3
Cobots	0	0	2	4	6
Loaders	0	0	1	2	3

Total output	5.000	3.000	5.200	7.400	9.600
Total input	15.500	9.300	13.300	17.300	21.300
Productivity factor	0,32	0,32	0,39	0,43	0,45
Increase as compared to manual work (approx.)	0 %	0 %	21 %	33 %	40 %



Operation-securing strategy with welding Cobots	Growth strategy with welding Cobots
Output can be massively increased	
Lack of specialists is considered	
Productivity is (in part greatly) increased	
Space to act for price competition	
Space to act to retain employees	

ADVANTAGES AND USE

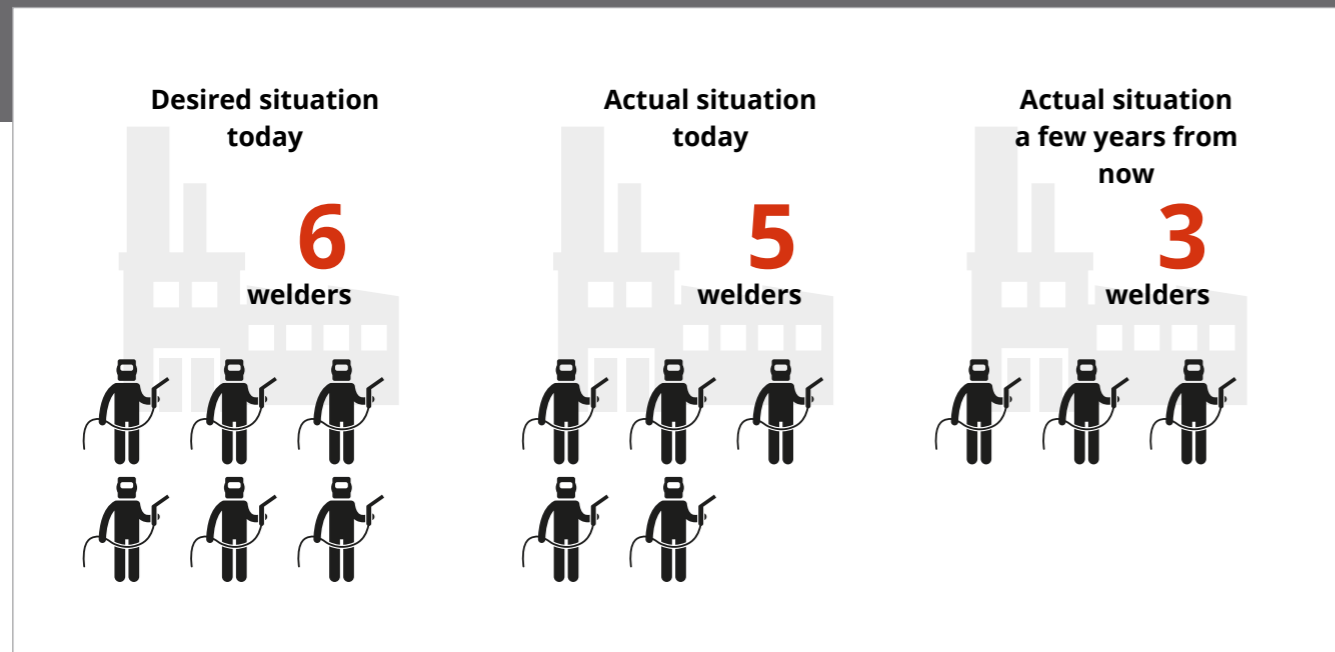

Future scenario: Reduction of own welding workforce by up to 40% due to retirement and lack of young talent

A solution for the shortage of skilled workers.

Source (current unemployment rate):

Relieve skilled workers, weld more efficiently, secure the future.

Many companies are acutely affected by the shortage of skilled workers. They cannot find enough people with the qualifications required for their vacancies. The occupational profile of welder is right at the top of surveys and statistics on sought-after skilled workers. The shortage of skilled workers in the welding industry is not a new issue, however. The DVS (Deutscher Verband für Schweißen und verwandte Verfahren; German Welding and Allied Processes Association) has already examined the situation

in more detail in a survey in 2007 and classified the shortage of skilled workers in welding and joining technology companies as a threat.

The welder gap is getting wider

The situation has only worsened since. On the one hand, far too few young people choose to become welders since the working environment and conditions of a welder are not considered very attractive overall. On the other hand, more and more older metalworkers are

nearing well-deserved retirement. While willingness to stay employed for a little longer has grown, this is naturally not a permanent solution. Many operations that would actually like to expand their welding workforce increasingly need to consider how to maintain production at the current level at all and the future of the company secured with a significantly reduced welding team.

Automation as a remedy

A way out of the overall problem of "skilled labour shortage" is usually going for a higher degree of automation. However, this has been a double-edged sword for the smaller and medium-sized operations so far. Welding cells equipped with conventional industrial robots generally do offer the relief desired. However, the investing companies also had to put considerable amounts into the training of the welding employees in order to be able to operate and programme the robot adequately. The expensively trained welders were subsequently even more interesting for the labour market and were often gone sooner than one thought.

Why is the Cobot better than the robot?

Why is this different with the Cobot? Everything is coming back to the familiar Cobot advantages of simple and intuitive operation. However, where welding is concerned, a supplier that extends the basic capabilities of the Cobot with welding software functionality that works with comparable ease should be chosen. It can be assumed that the time needed for initial commissioning of a welding Cobot and training of two employees does not exceed two days. The employees are then able to work productively with the Cobot right away, and to teach in new welding tasks. Robots, on the other hand need weeks to months to full qualification. The knowledge required for Cobot welding is much

easier to spread within the company as well. This also applies when changing personnel. Welders who have newly joined the operation will be able to work productively with the Cobot very quickly.

Employment in Germany

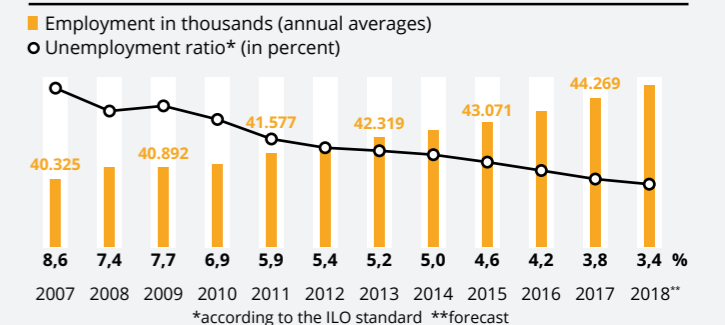

Source: EY

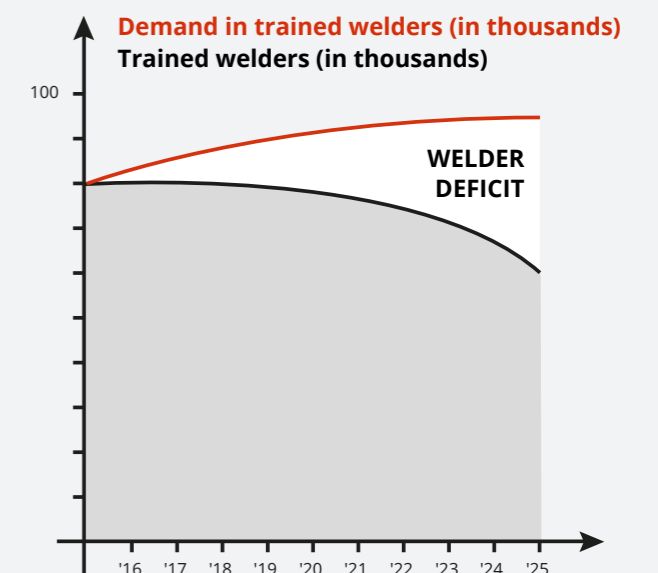

Due to the specific productivity gains to be expected from Cobot welding, the companies are once again in a position to stabilise the output performance of their operations in the long term, in spite of the reduction in welders that needs to be compensated for. Increasing the Cobot share (along with less qualified assemblers) also offers the possibility of growth potential for the company, in spite of the same number of welders.

Additional effect: Higher value of the welding activity

The "soft" factors associated with introduction of Cobot welding are important as well: The welder's workplace is significantly upgraded. Apart from the simple fact that the company is investing in the future of the welder's workplace and equipping it with the high-quality Cobot automation tool, the welder's daily work is changing in a fundamental way. They will be less concerned with the processing of manual welds and focusing more on set-up of the Cobot and qualitative monitoring of the welding process. In other words: the welding profession is changing into an occupation that increasingly includes the tasks of a production technician or quality assurance specialist.

Since the parts welded with the Cobot in the introduction phase mostly involve relatively simple welds and are to be processed in rela-

tively large numbers, the welders will be relieved of hated, monotonous, yet strenuous routine tasks right away. Employees benefit directly from the new technology and can be deployed to the more demanding welding tasks.

The flexibility of the "Cobot" tool and the daily involvement with it challenge and encourage the employees alike. Another effect is improved ergonomics and health protection: less time spent in strenuous positions, less exposure time to welding fumes, gases, and light emissions. This actively increases the overall value of human work and significantly improves identification with the company.

In times of a shortage of skilled workers, it is very much a question of retaining the good employees we have today. The Cobot makes an important contribution to this.

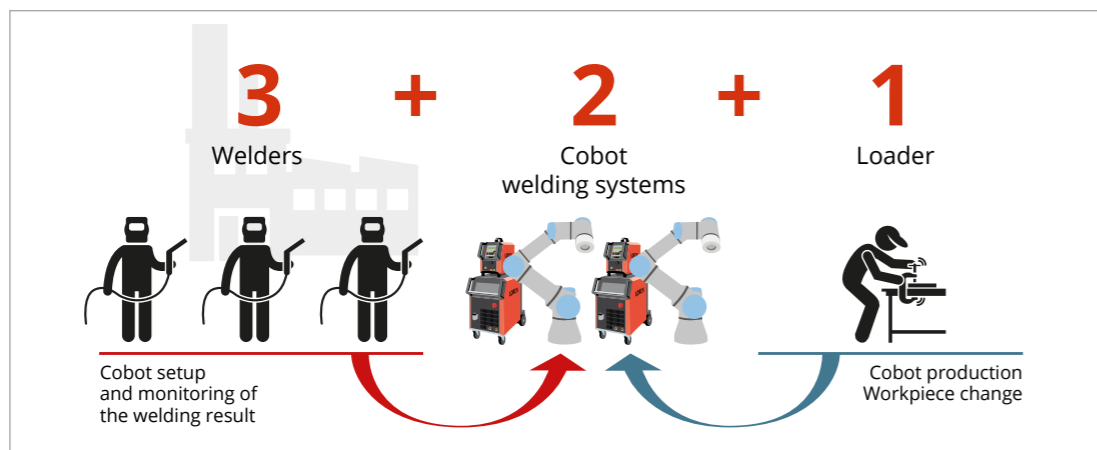

The new leading principle for workforce planning in welding operations

Compensation for specialist deficit - Output view of strategic options

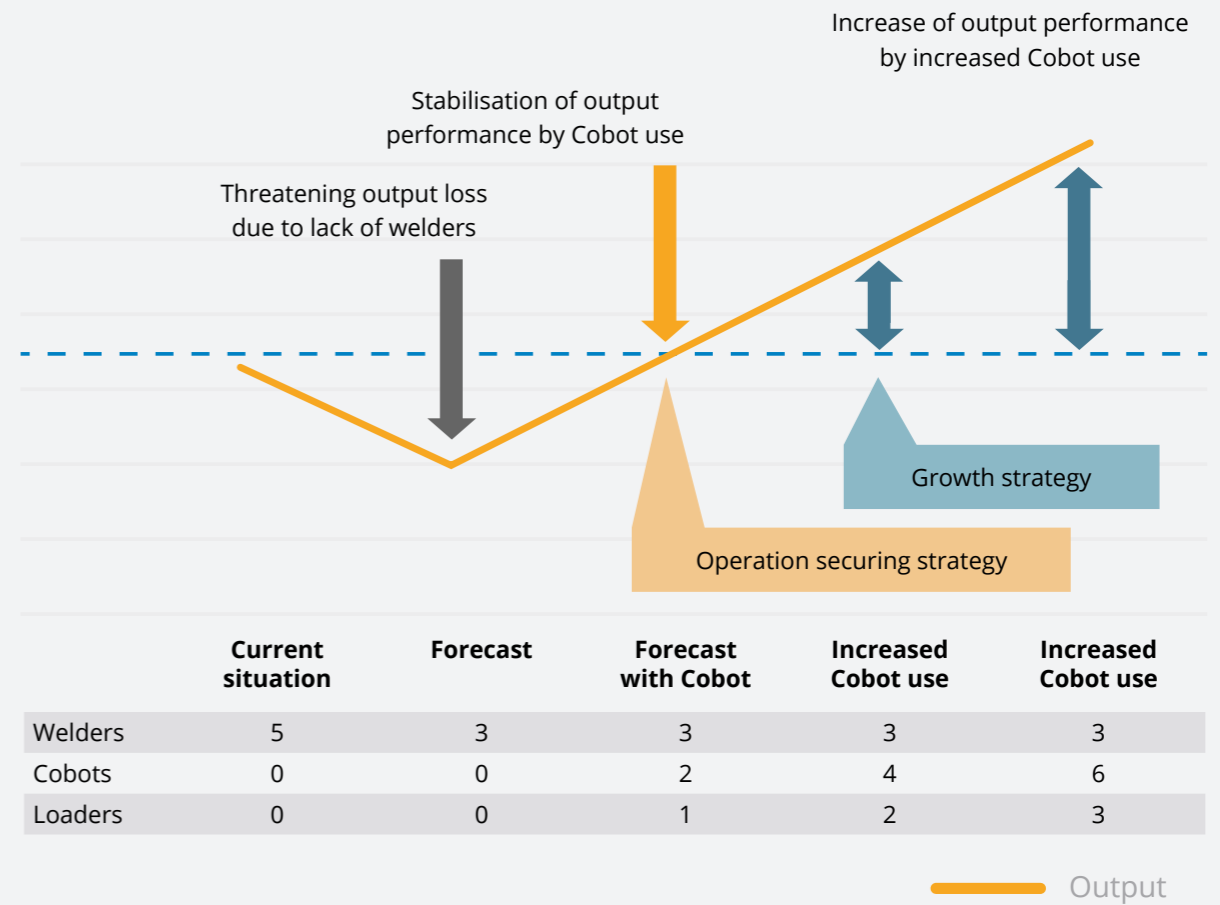



Cobot welding is attractive.

Retaining employees, finding employees.

Being attractive is increasingly important for companies and operations in times of scarce skilled workers on the labour market. This is a quality not commonly associated with the welding profession. Even if young people are interested in a technical/craft occupation, welding is hardly anywhere near the top. Other jobs on offer are cleaner, less strenuous, more technological, and, first and foremost, offer more opportunities for activity and development. Today's young people want to work with new technologies in their profession in the future. This is an essential aspect when they choose their training positions. Welding as such used to be not particularly desirable and rarely seemed progressive. This is where the Cobot's special charm comes in yet again.

Changed perception of your company

While conventional industrial robots are locked up in cells and not actually seen, the Cobot will be a visible element in a welding operation. It communicates modernity, technology, and also the future orientation of a company with its mere presence. Cobot welding workstations become a company's business card. They are usually better maintained and kept cleaner than other areas. The Cobot also represents an operation's willingness to invest in innovative technologies for the specialist area of welding.

Accompanying change in the welding profession from a craft metal fastener to a more industrially-oriented Cobot welding production

technician also brings the exciting task of solving the upcoming practical tasks with robot technology. On the other hand, it creates an ergonomically optimised working environment that offers challenging tasks and development opportunities and reduces physically strenuous activities. Cobot welding also is simply fun. Who knows what else the Cobots can be used for in your operation in future? Practice is the best proof of the positive effect of the Cobot.

The change in your own company

Our experience has shown that virtually all operations that have installed Cobot systems report positive aspects that can be observed with the Cobot introduction. High motivation of the staff directly involved in the initial projects was typical. Initial reservations quickly

converted into full enthusiasm. In this context, one operation was able to convince a young employee who had just successfully completed his apprenticeship not to move to a nearby larger one by offering him the opportunity to work with the Cobot. Many other operations report significantly greater interest from potential apprentices as a result of integrating the Cobot into apprentice recruitment as well. Cobot fascination is something everyone can experience directly.

Positive experiences of Cobot users



"Welding process automation suddenly turned out to be quite easy. This surely will not have been the last Cobot – nor the last welding Cobot from Lorch – to enter our company."

**Peter Hodapp, managing director,
Hodapp GmbH & Co. KG**



"We have significantly strengthened our competitiveness by using the Lorch Cobot Welding Package."

**Stephan Böhnlein, production department head,
Rösler Oberflächentechnik GmbH**



"Once optimally set, the weld seam produced by the Cobot warrants consistently high precision and quality. This is a clear benefit even in production of small batches, gaining valuable time while avoiding scrap."

**Roland Rinnergschwentner, managing director,
Reku Produktion & Entwicklung GmbH**

ADVANTAGES AND USE



Step by step on the way to digitalisation

Your step into industry 4.0.

Cobot welding as a new key technology for SMEs.

"Industry 4.0" is one of the greatest buzzwords of the last few years. The term represents an enormous change in the way we will manufacture our products in the future. There is hardly a provider of services and products who does not boast of being able to offer some kind of solution to this complex of issues. The problem is that the term is extremely broad and, therefore, associated with an extreme variety of individual subjects.

First of all, it must be determined what parts of "industry 4.0" are truly important for any one specific range of tasks or the company's future. Furthermore, the sensible chronological sequence in the approach must be determined. The core objective of industry 4.0 is achieving digital management and control of all internal processes in the end. In welding technology, this is also referred to as digital welding production management (in short: SFM).

However, this assumes sufficient networking of operating resources and workplaces and that the processes can be transparently traced. It may sound quite harmless but constitutes quite a high entry hurdle due to the complexity involved in welding practice. Experience shows that implementation of industry 4.0 is easiest for operations that already have a relatively high degree of automation and thus work largely digitally. Automated welding also allows a new level of quality control. In contrast to manual welding, the welding speed, for example, can be clearly determined and easily controlled digitally in the SFM.

The approach is decisive

In contrast to machine-dominated areas such as milling or turning, welding production is a highly manual activity in the vast majority of operations today. The result mostly depends on the manual skills of the individual employee.

Considerable effort, investment and persuasion are necessary to digitally equip, connect, and control such workplaces in the necessary breadth for an SFM. However, a short-term compensation in the form of increased productivity or simplification of work is not to be expected.

The first step is sensible automation

The key to tapping into future potential with industry 4.0 and not remaining behind competition in the long run is to automate your production sensibly step by step in the first stage. This automation necessity can be implemented excellently with the Cobot for a large number of companies that are confronted with small and medium series of frequently changing parts when welding. Cobot welding means a quite significant change for the employing operation. However, a change that leads to an increase in throughput and quality at a manageable cost and makes welding work less strenuous for the employees.

The decisive advantage is that the Industry 4.0 technology "Cobot welding" does not have to be introduced for all workers right away, but that one can set an initial impulse with the most motivated and qualified employees. This is important in order to bring about a general open-mindedness among the workforce for the major changes that are imminent as a result of industry 4.0. This is particularly true in a field such as welding, where welding unit technology has developed enormously, but there have been no fundamental technological changes for employees in recent decades.

Human-robot collaboration has a central role for further entry into and success with industry 4.0. On the one hand, the technology is directly available and immediately has a positive effect

on productivity and the degree of automation. On the other hand, it contributes actively and preparatory to the necessary digital transformation in a company's welding operations.

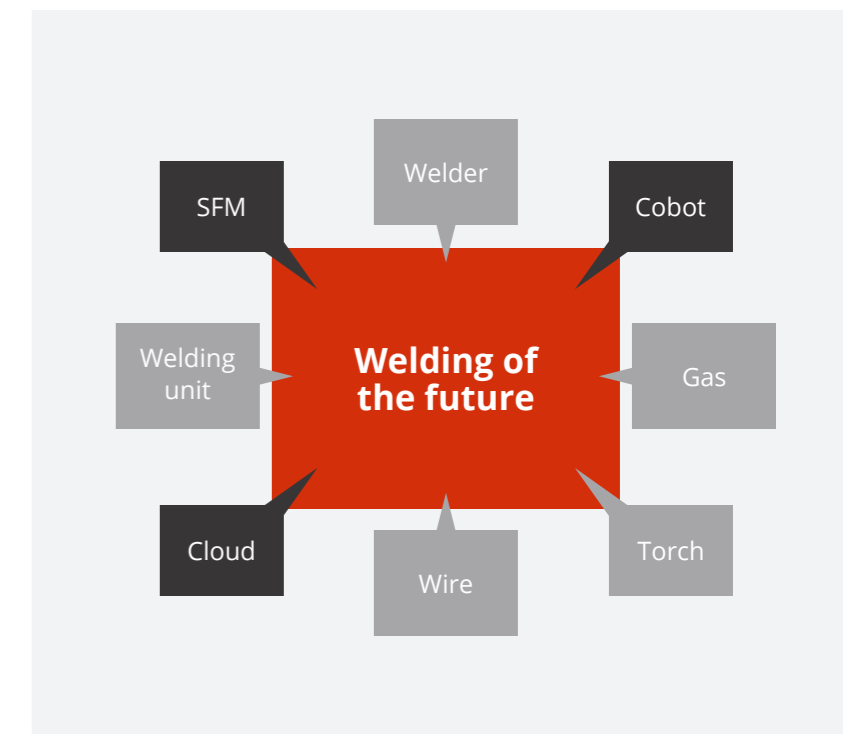



Source: iStock.com/putilich

Transparency by networking.

The next step is creating transparency.

Companies are often subject to high cost pressure. They need to calculate their projects closely – without letting quality suffer. This is a great challenge for companies that often do not have any opportunity to take a closer look at the welding process or the welding production, as it is a little-lit and undocumented process.

The networking of welding machines can suddenly give a company entirely new options for gaining insights into its production. Valuable information from the welding units, apparently inaccessible until then, can now be accessed and utilised via connectivity. There is suddenly an opportunity for digital monitoring, easier cost controlling and better traceability.

A wide variety of data can be collected, such as weld seam and machine details, processes used, responsible welder, associated jobs and part numbers. These production-relevant key figures are transferred to the cloud via the networked systems, where they are processed, evaluated, and visualised. The company can enter further specific data via the cloud application, such as the costs for welding and additives or labour costs. This information is processed in the application to provide the customer with a view into the actual costs of the weld seams, jobs, and parts. These digital services can also transmit the welding speed and power consumption in the field of automation so that the relevant welding data can also be retrieved and evaluated when used with a collaborative robot.

Networking creates transparency, which in turn generates new opportunities to optimise one's own processes and uncover potential for improvement. The entry into Industry 4.0 can therefore also pay off directly in monetary terms.

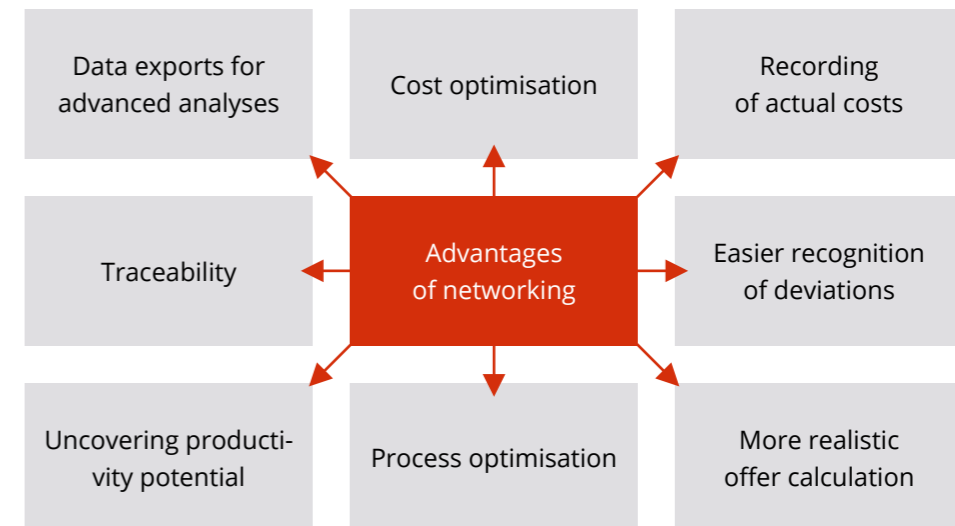

Good to know:

Lorch Schweißtechnik offers the Lorch Connect product in the area of networking and digitalisation. It can be installed without considerable effort and large investments. It enables processes to be seen through and optimised down to the last detail. This avoids unnecessary costs, improves product quality, and may acquire a decisive competitive advantage. It's all true to the motto of: **Connect. Weld. See clearly.**

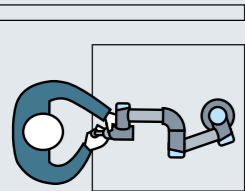
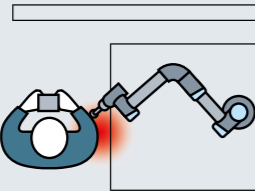
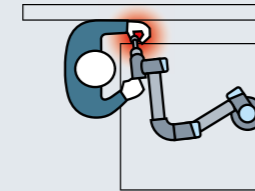
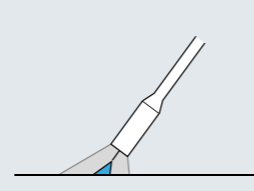
Desired contact	Danger source: Undesired contact		Potential dangers
 <p>Fast, uncomplicated setting of the Cobot</p>	 <p>Safe collision detection and reduced speed</p>	 <p>Limit values for force must not be exceeded</p>	 <p>Protect from contact and direct exposure. Powerful burner cooling</p>
Guiding the robot arm/torch	Free temporary contact	Quasi-static contact	Arc, wire, hot torch

The matter of safety.

Proper handling within the operation.

Safe operation of the system is one of the central requirements of Cobot welding. The particular challenge here comes from the fact that the desired productivity-enhancing contact between humans and robots is to be preserved while avoiding undesired contact or minimising possible negative consequences from it. The latter is a frequently underestimated component in collaborative robotics projects, strongly related to a general norm-technical feature of industrial robots.

Not all CEs are alike

All industrial robots, i.e., conventional systems as well as their collaborative counterparts, comprise "incomplete" machinery within the meaning of the European Machinery Directive. This is because safety-related statements on the overall system are impossible without also considering the specific task, in particular the limit values stored in the robot and the tool attached to the robot arm. Though robot manufacturers to compile CE declarations of incorporation for their products, the CE mark in accordance with the Machinery Directive must

not be affixed to such incomplete machines. Only the "complete machine" must be applied with the CE mark after a safety-related consideration of the overall system prepared for a specific application (such as the welding of defined parts). As a result, the party providing and parametrising an overall system and integrating several components with each other bears the responsibility for carrying out the CE conformity assessment procedure as well as the CE marking. Preparation of a comprehensive risk assessment for the entire, specific application with all its parts including hardware and software optimisations and preparation of corresponding documentation and an operating manual for the entire system based on it is an essential part of the assessment procedure.

How is the Cobot system made safe?

A system in which a Cobot is installed is not safe by default. It requires a separate CE marking. Unfortunately, this may be precisely the point where negligence happens in practice. One reason for this is that Cobots, such as those from Universal Robots, are already delivered

from the factory with power and force limitations in effect. The contact forces between the employee and the robot are technically limited to an apparently harmless level by this. In fact, however, the proper safety settings and limit values of the Cobot depend on the specific application. They must be carefully determined by the manufacturer of the overall system, otherwise no truly safe operation is possible. The typical approach is that of contacting a system integrator familiar with the specifics of creating automated applications and able to integrate different contracts with each other to form a complete system. An integrator experienced in welding should be able to perform the risk assessment and declare the CE conformity of the installation in accordance with the applicable legal situation as a matter of course. One special feature of collaborative systems is that testing, in particular of the limit values to be complied with for forces acting in quasi-static contact between robots and humans, requires special measuring equipment and corresponding specialists. It may be a very time-consuming task since repeated modifications may

be required to the overall system in order to achieve the desired "safe" results.

The Cobot as a welding package solution

Classic sales channel with project handling via system integrators are supplemented by package providers that offer complete, standardised application solutions, in particular in the field of Cobot welding. Simplifying, these package systems have the advantage of effort and costs for risk assessment only being incurred once for a large number of systems. Serious providers of such packages are thus able to deal very intensively with the topic of security and at the same time still keep the costs per system manageable. This enables these systems to offer optimal price-performance combinations without compromising on safety.

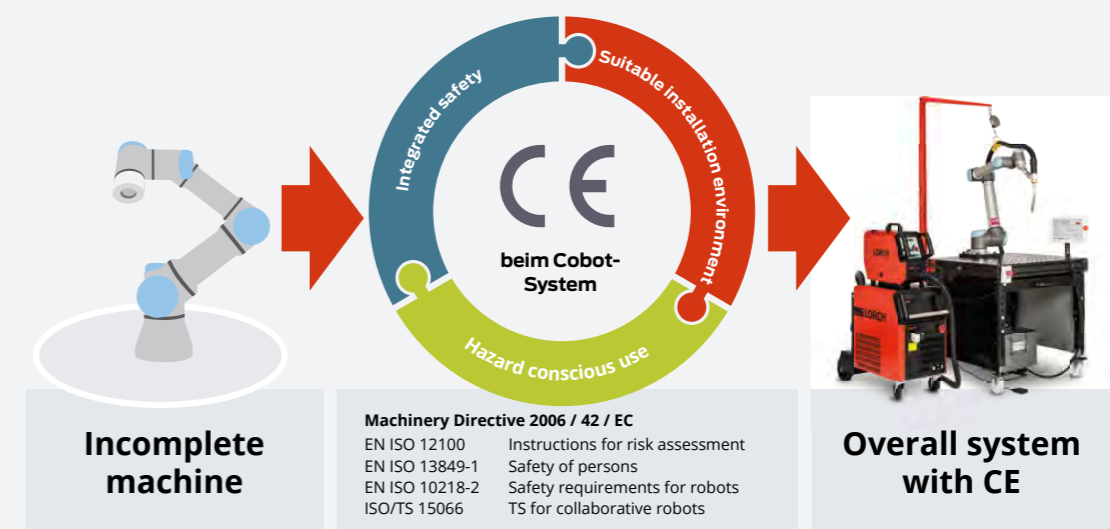

However, a package solution alone does not warrant compliance with standards and regulations. An end customer must find reputable suppliers with a safe overall concept, documented by a CE mark for the entire system, and not to be satisfied with statements such as "robot and welding system with CE". Some package providers leave the customer relatively little scope for design; for example, a welding table of very specific dimensions may need to be used or even purchased as a mandatory extra. Others give their customers greater flexibility here since the correct safety settings are ensured by suitably qualified partners on site. Apart from the safety aspects that are integrated in the package solution and correctly set, a suitable installation environment in accordance with the manufacturer's specifications as well as to hazard-conscious use (with accompanying safety-related instruction of the employees) are also essential when Cobot welding. The matter of work safety as well as the provision of suitable personal protective equipment is basically the responsibility of the operator.

Dealing with welding-specific risks

Welding as such comes with a number of specific risks that must be taken care of in both manual and automated welding operations. This typically includes protection against blinding/flashing of the eyes by the arc. This applies to the welder but also to third parties. Introduction of a Cobot welding system, therefore, does not usually require a completely different approach to that which has been common in previous operational practice for manual welding. Appropriate eye and face protection must be provided, warnings to wear eye protection must be put up, and privacy screens or similar items must be installed as typical solutions here. However, aspects of safety that are particularly important for the Cobot must be observed particularly. While the welder is a factor in accident prevention by handling the

torch with care and control and by keeping or moving a hot torch neck away from other people and themselves in manual welding, this is not the case with a Cobot. A torch standing in the room may at times irreversible injuries due to hot surface or by the wire tip that must not be underestimated. This risk must be reduced to a minimum by appropriate measures and hazard-conscious use. For example, always ensure that the welding torch is pointing downwards when programming the Cobot movements. In addition, welding systems with water-cooled torch systems are clearly preferable for collaborative use, ideally equipped with dual-circuit cooled torch necks and cooling system with increased capacity.

Proper definition of collaboration space and installation environment

Establishment of the Cobot's movement limits is an important aspect here. In order to exclude any incidental danger to persons standing nearby as far as possible, the outer dimensions of the welding table used are the surface-technical framework that the Cobot arm or the mounted tool (i.e., the torch or torch tip) should stay within. The welding table usually marks the actual collaboration space in the welding application. All risks not protected by the Cobot's force-power limitation must be within this zone for operation. Ensure that there is sufficient freedom of movement for the operator to move on all accessible sides of the welding table.



The following aspects are particularly important in operational practice:

- Comply with the intended use of the Cobot welding system as defined in the product documentation, including correct definition of the Cobot work area
- The safety functions must be proven to be adjusted to the external dimensions of the welding table upon first commissioning and this must be reviewed at regular intervals
- Observe all safety instructions in the enclosed documentation or operating manual
- No matter the setup or welding operation, always ensure appropriate personal protection (in particular regarding eye protection and suitable gloves)
- Any change to the installation should be considered to determine whether a new risk assessment or adjustment to the Collaboration Zone needs to be performed. This also applies to the installation of additional parts, structural changes, etc. In many cases, the provider of the package solution can assist here with a renewed risk assessment

How to ensure that you are receiving a CE-compliant Cobot welding package.

Example: Lorch Cobot Welding Package



The key to success.

Technology is important.

But you and your team are the be-all and end-all.

A Cobot is an easy-to-operate automation tool. It is rather likely that you will get on well with it in your operation and be able to use the Cobot productively. Of course, it is all about getting the most out of an

investment for your operation for you. Naturally, it is very important to be clear about the overall system and the right technology for Cobot welding:

Safety first: The Cobot as such offers many possibilities – for example, it can be operated like a classic industrial robot in terms of speed. This may be tempting at first glance, but then it is often no longer compatible with collaborative use. As explained in the previous chapter, both observe the selection of a reputable implementation partner and pay sufficient attention to the security issue itself – especially during the later normal operating phase.

Welding speed is not the only decisive factor to determine whether the introduction of a Cobot system makes sense for your operation. However, a close look at the process-technical options of the welding systems is a good idea. Experience shows that automated welding on the Cobot optimises the weld seams more and uses modified arc processes with special properties much more extensively than manual welding in order to achieve an optimum result and minimal rework. The associated faster welding process is, of course, another welcome side effect with Cobot welding.

Welding functions that help you be better at your job. You are generally able to weld even with the standard software from Universal Robots. However, it only has a limited range of functions in the sense of a job operation. Welding parameters are stored separately from the programming of the robot movement in the power source. It generally is more useful to store all important settings in the Cobot control and to make a backup of them regularly. The more deeply integrated the welding system and Cobot work with each other (e.g., in the form of welding parameter assistance systems), the higher the ease of use, scope of performance, and further development potential for your Cobot welding system.

Practical training and commissioning: A very important factor in how successful your start with Cobot welding will be is the initial training of your employees and the commissioning on site. The closer the training of the employees with regard to their daily practice and the parts that are eligible for automation, the faster your company will work productively with the welding Cobot. Practice-oriented, application-related on-site training is preferable to universal training.

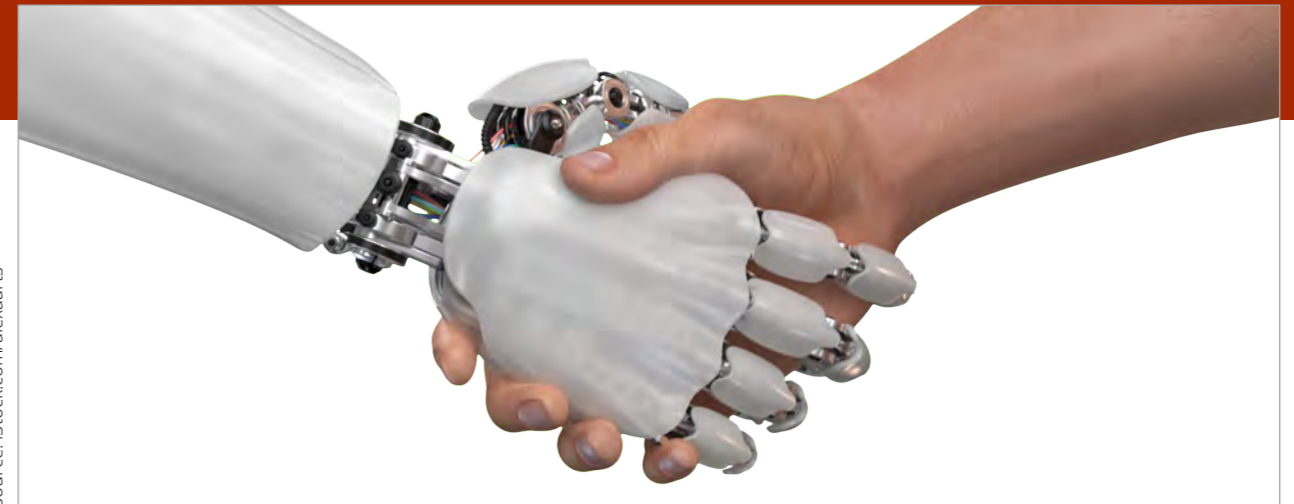

Source: iStock.com/alexarts

There is another decisive component apart from the technical aspects: the personal approach to introduction. In particular operations with little or no prior experience with automation should deal with this very consciously. In contrast to classic robot projects, where

the system integrator virtually takes care of everything and wants to be paid for this, with Cobot welding you as the customer are always part of the solution as well:

Cobot welding is automated welding. Remember that although Cobot welding is – perceived as – much closer to manual welding than previous automation approaches, it still is a kind of automated welding. As a result, it has some specific requirements that must be met in order to produce good results. The welder compensates for many things that are not optimal for the robot with his human sensors and welding experience. Therefore, devices previously used for manual welding are usually not suitable for the robot due to their tolerance adherence. Automated or Cobot welding has a higher requirement to prefabrication. This generally requires a greater degree of attention.

Cobot "YES", continue as before "NO". Assuming that a Cobot can simply weld all parts just as they used to be will quickly hit its limits. The willingness to implement changes is important to achieve a higher level of automation and a higher proportion of Cobot-welded parts. The more complex the parts, the greater the need to think of and in special clamping devices and, if necessary, to make design changes to workpieces that make Cobot welding more feasible.

Cobot welding equals teamwork. No one knows your materials, workpieces, and parts better than you and your employees do. As a result, you need to get the right people from your operation involved from the very beginning. The more open and receptive the employees are to the new technology, the greater the operational success. The corresponding time for training the Cobot team must be planned as well.

Operational communication is important. Take your employees along specifically and alleviate any fears they may have: The Cobot is not a competitor. It helps the company and its employees to move into the future. It may make sense to coordinate the introduction of a Cobot with, e.g., the works council, occupational health and safety officer, company doctor and, if necessary, other parties involved, including the employers' liability insurance association, depending on company size.

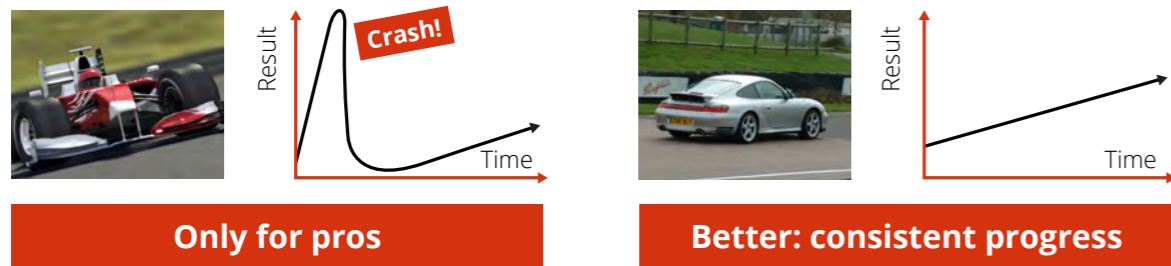

The targeted path to introduction.

Learn how to optimally use your new Cobot tool.

Human-robot collaboration is different from the automation that is predominant at the moment. There is no cage, people remain involved, and, first and foremost, it is easy to use. Rather than the automation specialist (often contracted externally), the company's own process or application specialists are at the centre of this new automation technology – in our case, this means the welders and those responsible for welding in the companies. This greatly increases the flexibility of operations to adapt automation to their own needs on the one hand and to changing market requirements on the other, and to develop it further in a targeted manner. For this to be successful, a few simple recommendations need to be followed when introducing Cobots or Cobot welding:

Take yourself to task. Cobot technology provides the simplest way to operate and programme a robot to date. It is, in fact, so simple that we no longer talk about robot programming, but robot training. The Cobot offers them

the chance to become masters of automation themselves. Take advantage of this.

The central element is "learning by doing". The employees designated to weld with the Cobot in the first step should be given sufficient time resources for this task. Following initial training, which includes the relevant basic function for Cobot welding, the employees can and should continue working directly with the Cobot. It is important to be able to simply try things out to find out what works with the Cobot and what doesn't.

Start out with a small team. Training is most effective when it is intensively centred around a small number of participants. The beauty of the Cobot is that the simplicity of its system will allow your own employees to easily pass on the acquired knowledge to their colleagues.

Just get going. Start out with simple applications and workpieces rather than complicated ones. This warrants a quick sense of achieve-

ment and creates a reasonable starting point. Then gradually increase complexity and allow for a necessary learning curve from the outset.

Choose the first parts with care. Familiarity with and availability of these pays off even for the initial training. Ideally, the parts are none too complex and produced repeatedly in batches of a certain size.

Think about the welding preparation and fixtures needed. Welding has a thermal effect on the materials to be joined. Various parts can only be welded automatically if (positioning) devices are available to allow repeatability. The sooner this is understood (if possible, this should be done even before introduction), the sooner welding with the Cobot can be mastered productively and in a manner that increases productivity. Ideally, you as a user will also be able to build your own devices. After all, you are dealing with the subject matter in depth this way while this also constitutes the quickest way to react to new requirements and parts and implement them in production.

Be open and ready to make further changes. Starting with Cobot welding often leads to questioning existing approaches. Some seam preparation simply involves too many tolerances; some part designs are simply suboptimal for clamping and positioning. Cobot welding is not about "continuing as before" with different means. It very centrally focuses on how to become even better in the future. The willingness to optimise the design of workpieces for Cobot welding (e.g., by avoiding corner welds or by increasing tongue-and-groove designs for easier positioning of the starting sheets) is a factor for success.

Challenge yourself without overextending yourself. Cobot welding is a powerful new technology for many operations – with no prior experience in automated welding – that brings a lot of change to a company's welding range. It does not make sense to start directly and maximally from zero to one hundred. Start with a Cobot system first and, for all your ambition, plan a learning curve for yourself and the company. In contrast to conventional robot projects, where you have to put in a lot of requirements right from the start, Cobot welding allows you to get started quickly and easily without getting bogged down for weeks and months. Harvest the first fruits early on and, building on the experience, analyse how to approach further implementation in your own company.

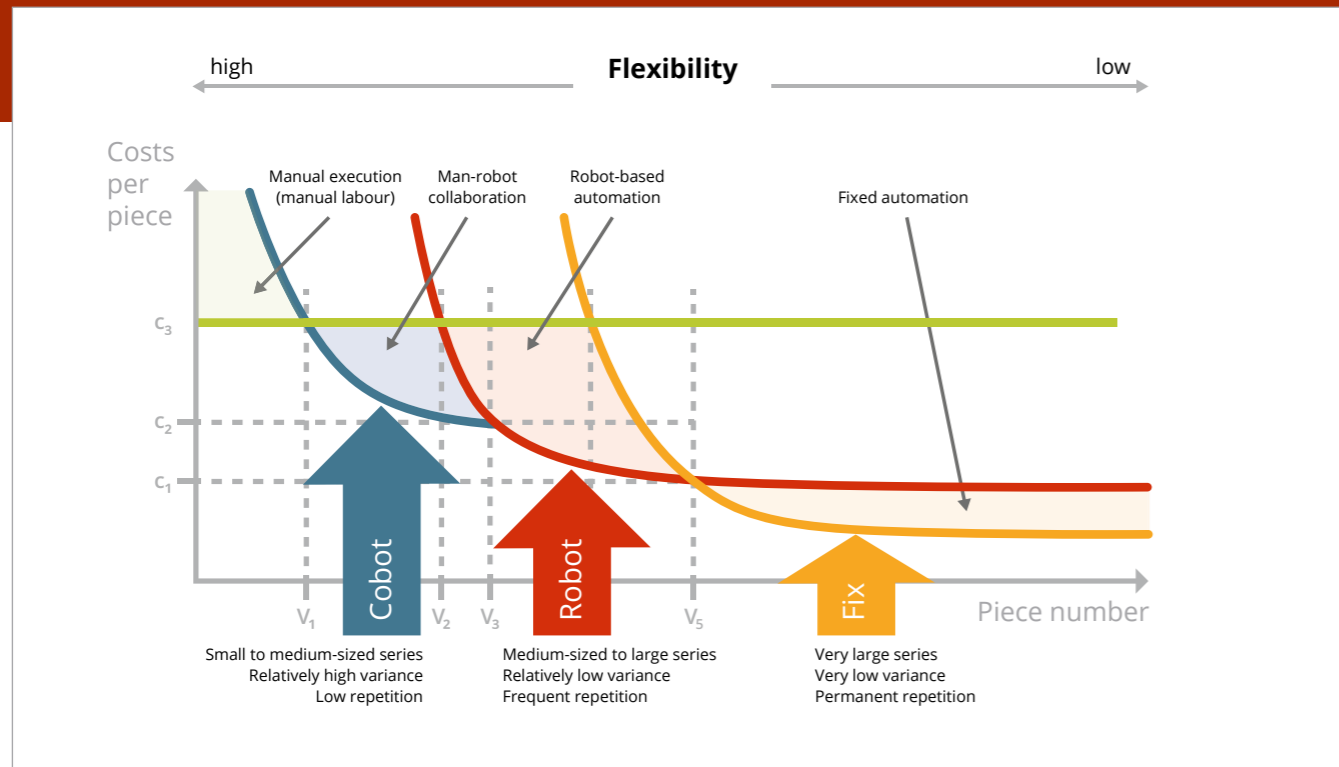

Adapted from Weber, M.-A.; Mensch-Roboter-Kollaboration; 2017 und Matthias, B.; Ding, H.; Die Zukunft der Mensch-Roboter-Kollaboration in der industriellen Montage, 2013

Investing the right amount of time.

Sophisticated technology and modern financing concepts.

Every investment in something new moves us humans intensely. Internal resources in particular have limits. A bad investment would lead to considerable restrictions of personal possibilities in the future. New technologies specifically come with the uncertainty of whether a technology will actually become established in the future or whether it means backing the wrong horse. Many a prominent, and in retrospect extremely amusing, misjudgement shows how difficult it is to look ahead. Emperor Wilhelm is said to have said in 1904: "The car has no future. My money is on the horse." And Got-

lieb Daimler's assessment in 1901 was: "Global demand for cars will not exceed one million – if only for lack of available chauffeurs." These two examples illustrate very well what is important in determining whether a new technology can become established: It must be able to overcome previous limitations and offer true added value.

Human-robot collaboration is increasingly gaining acceptance

Asked whether we could imagine working hand-in-hand with a robot in the early days

of this century, I don't think any of us would have thought it possible. The fact that Cobots eliminate previous limitations, both in comparison to manual welding and in relation to conventional industrial robots, has already been presented in the previous chapters. Forecasts predict that the Cobot market will grow by 15-20% by 2028. The demand for Cobots is increasing significantly in particular in China.¹ Human-robot collaborations represent the fastest growing market segment in robotics.

The fact that Cobot pioneer Universal Robots has been actively selling its Cobots on the market for more than a decade clearly shows that Cobots have become a mature technology in the meantime.

¹ Martin Large, All Electronics (2021); Cobot market survey; <https://www.all-electronics.de/markt/marktstudie-cobots-das-marktwachstum-geht-2021-weiter.html>



INVESTING THE RIGHT AMOUNT OF TIME

Early issues in use of collaborative robot systems have been fixed in the course of several years of successful use and further developed. According to Universal Robots, the company has achieved proof-of-concept and is fully focused on its growth strategy with more than 50,000 Cobot systems now in use. The range of applications, from use in the automotive industry to the smallest manufacturing company, is also proof of the new technology's applicability. Other Cobot manufacturers can also be used after reviewing their suitability for a welding operation. The world's leading Cobot suppliers, Universal Robots, Techman, Fanuc, and AUBO, accounted for more than 60% of the market share together in 2020. It is particularly important to choose a brand that will still be available on the market in a few years' time for SMEs and small businesses, however. Another reason to postpone an investment for a little while longer, if necessary, is the expectation that market prices is going to drop significantly. Falling prices are due to increasing competition

from more Cobot suppliers entering the market, while the forecast huge demand for collaborative robot systems drives prices up again in return. It is impossible to make a reliable forecast at this point in time. In the end, however, price development is only relevant if it significantly influences an investment's amortisation calculation. This is more likely to be the case with the Cobot. In particular, operations that are thinking about purchasing a Cobot system instead of a desired but unavailable welder due to the increasing shortage of skilled workers will very quickly realise that the investment virtually pays for itself after just a few years due to the labour cost savings achieved.

Interesting financing and leasing models

Another argument for not delaying the purchase any further lies in the interesting financing and leasing models that allows paying off the Cobot with a low monthly charge. Assuming an investment volume for a Cobot welding



system of around EUR 60,000, the monthly charge is currently only around EUR 1,200 and expires after a few years, whereas the wage costs of a hired welder continue permanently.

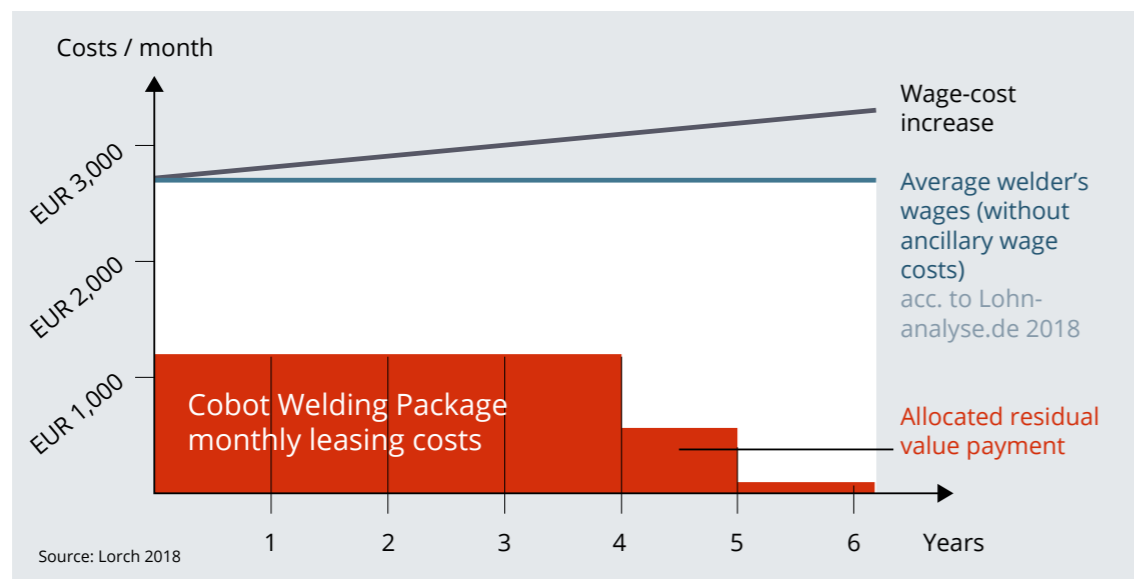

Welding Cobots are going to become an integral part of welding production in the future.

Welcome your new team member. The sooner, the better.

First-class welding technology and maximum service.

FIRST CLASS ADVICE AND SUPPORT

Advice	Transparent advice based on your work processes and objectives
Individual complete solution	Perfectly coordinated components for intuitive operation and efficient work
Financing, leasing, or rent	Attractive offers from rental to financing of your function package
Structure and assembly	Reliable construction and integration until commissioning of your plant
Training and education	Immediately productive thanks to easily comprehensible training on operation and functions
Customer service	Our qualified Cobot partners are at your disposal with comprehensive services

More information on the Lorch Cobot Welding Solutions at www.lorch.eu/cobot-welding

The modules: myCobot

Customise automation solutions with Lorch now.

Cobot UR10e – the latest robot technology from Cobot market leader Universal Robots.

BASIS	Welding procedure	MIG-MAG For full efficiency and high-quality weld seams.	TIG For highly demanding and visually high-quality weld seams at the highest speed.
	Power source	S-RoboMIG XT series FullProcess equipment with high-end control technology.	V-RoboTIG series Fast pulse technology. Optionally with digital fully integrated cold wire feeder.
	Cobot torch	LMR torch system With dual-circuit cooling for longer service lives. With an optional push-pull variant.	LTR torch system With hybrid cooling concept. Optionally with robust cold wire guide.
	Control software	Lorch Cobotronic Unique software for greatest comfort and efficiency.	
	Quality management	Lorch Connect Digital welding data acquisition for the analysis and specific optimisation of processes.	
OPTIONS	Hardware	Cobot Move The linear axis for more workspace and maximum flexibility in the welding process. With constant welding quality across the entire workspace.	Cobot Turn 100 A The turn-tilt table ensures the optimal welding position. The precise positioning for each weld seam can be specified in the programme process.
	CE-compliant safety concepts	Collaborative safety concept Safety option with best accessibility. The Cobot is protected in its interaction with the operator by internal safety functions in productive operation.	Laser scanner safety concept Safety option with additional safety parts. A laser scanner or function button is used to give the go-ahead for interaction with the Cobot or for productive operation.
	Cobotronic features	QuickPoints Weaving Interval welding SmartCopy ... and others	
Accessories/extras	Multifunction flange Control panel Additional emergency-off switch		



MADE IN GERMANY

Lorch Schweißtechnik GmbH
Im Anwänder 24 - 26 · 71549 Auenwald · Germany
T +49 7191 503-0 · F +49 7191 503-199
info@lorch.eu · www.lorch.eu

LORCH
smart welding

EN | 04.2023 | Technical changes, price changes, and printing errors reserved.